

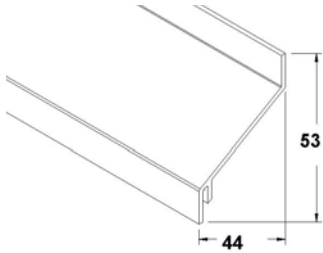

I.D. ALU

ID-LAMES-001
Brise soleil pas de 50mm
Notice de montage

B



lame-5012

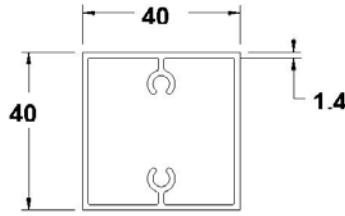

profil porteur-9040

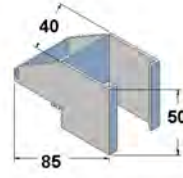

entretoise-5313

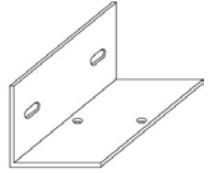

fixation des porteurs-5315

1.

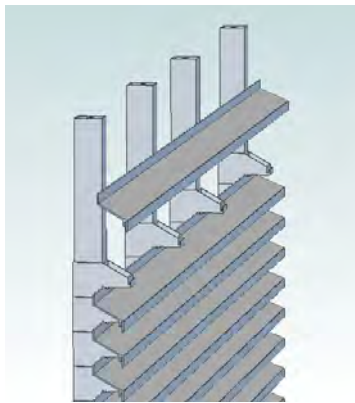

2.

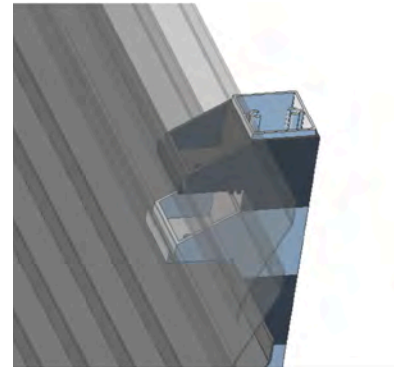
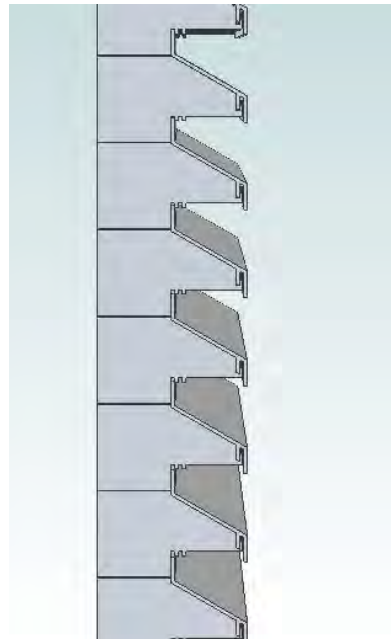

3.

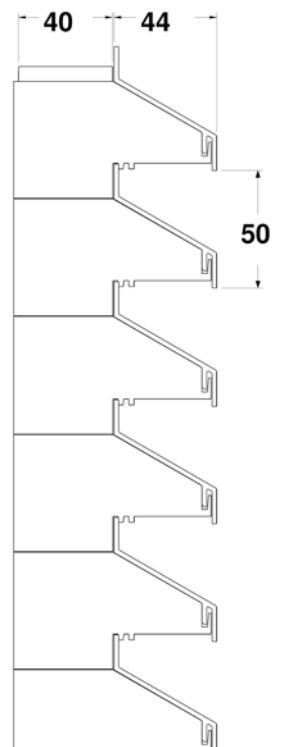
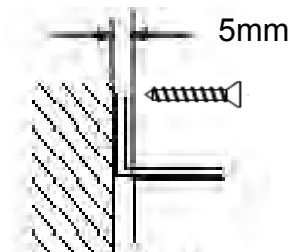
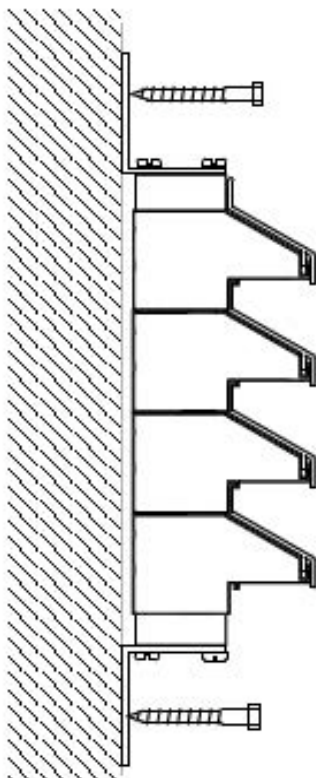



ID-LAMES-001
Brise soleil pas de 50mm
Notice de montage

B

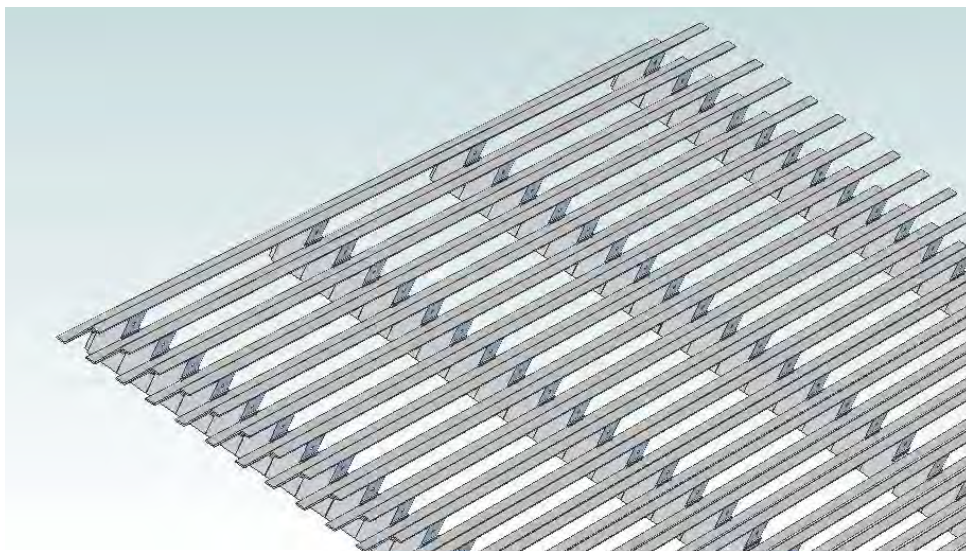

Conseil technique : un profil porteur (ref 9040) tous les 1,5 m
Les équerres préperçées permettent de fixer les poteaux 9040 au mur et garantissent un espace entre le mur et le poteaux pour glisser les entretoises plastiques 5313
Le montage s'opère en commençant par le bas du bardage.

